

VIBRATION

This outdoor interactive installation emphasizes the power of vibration as a unique form of communication between individuals on campus.

Through the vibrations of interconnected rope structure, people become aware of each other and can naturally interact with one another. As a result, this installation not only enriches the campus environment but also fosters a stronger sense of community and connectivity among the its members.

The installation transforms an overlooked space between the Global Village and academic buildings into a dynamic, multi-purpose area that encourages individuals to engage with one another. Those who encounter this installation will find themselves relishing their surroundings and immersing in a shared and harmonious experience together.

Everything we design is a response to the specific
climate and culture of a particular place.

- Norman Forster

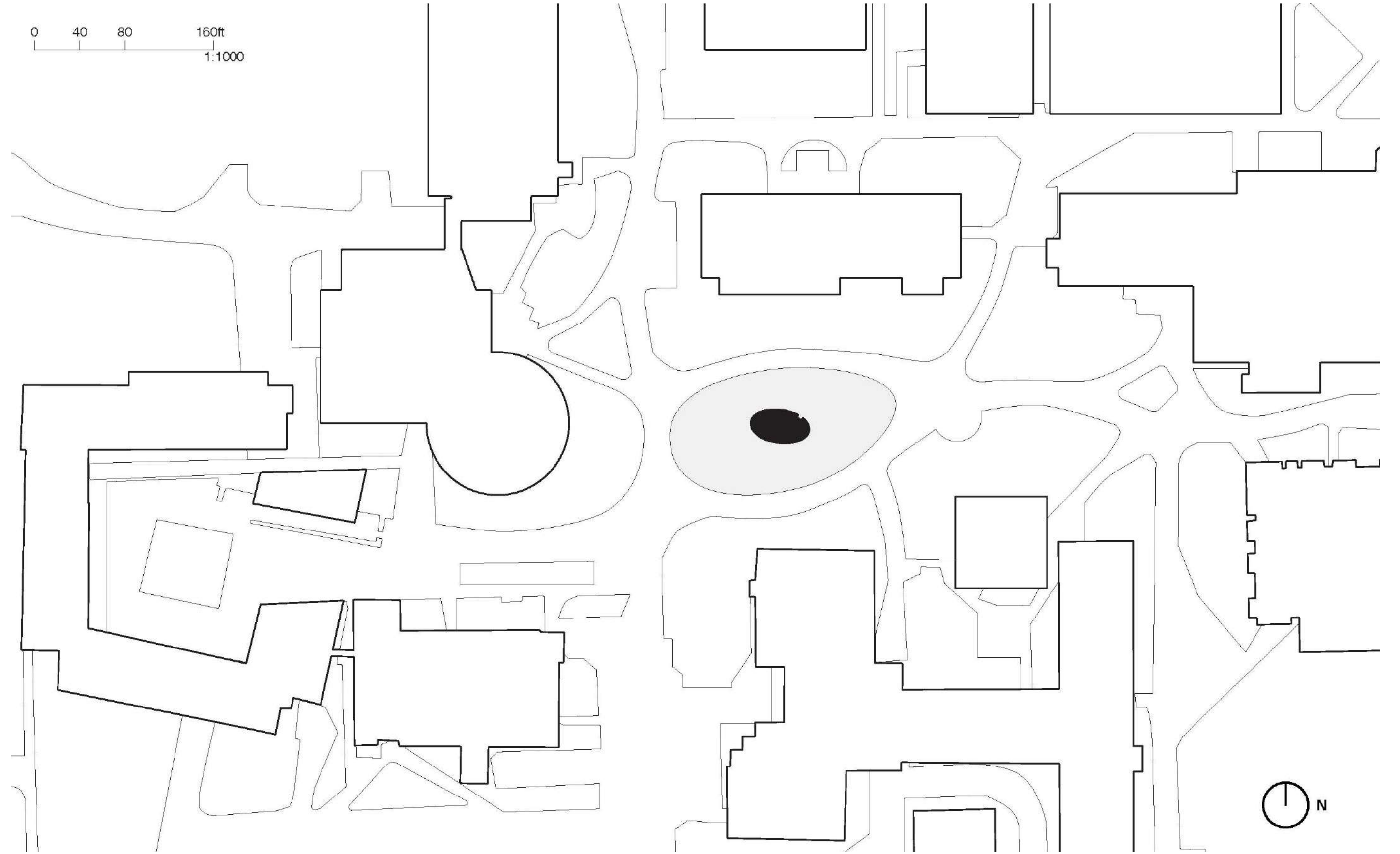

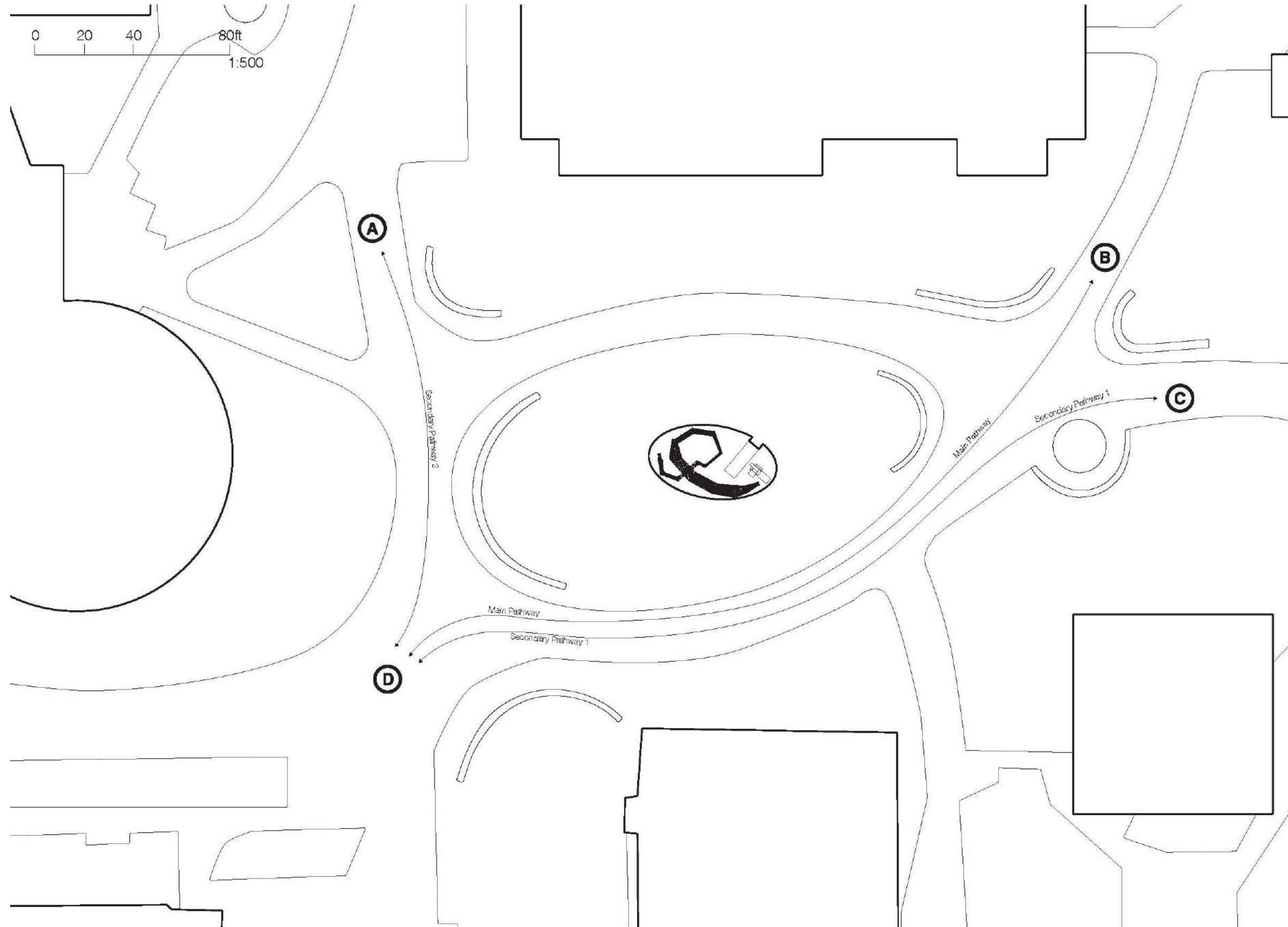

- A**
 - Golisano Hall
 - Kate Gleason Hall
 - Simone Center
 - Music Performance Center*

- B**
 - The Quarter Mile Walkway
 - Infinity Quad
 - Library
 - James Gleason Hall
 - Booth & Gannett Hall
 - Residence Halls

- C**
 - Gene Polisseri Center
 - Gosnell Hall
 - Saunders Business School
 - Gleason Circle

- D**
 - Global Village
 - Student Housings
 - Salsarita's (Cafeteria)
 - Crossroads (Cafeteria)
 - Midnight Oil (Cafe)
 - Global Village Market (Grocery Store)

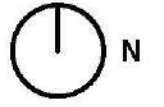



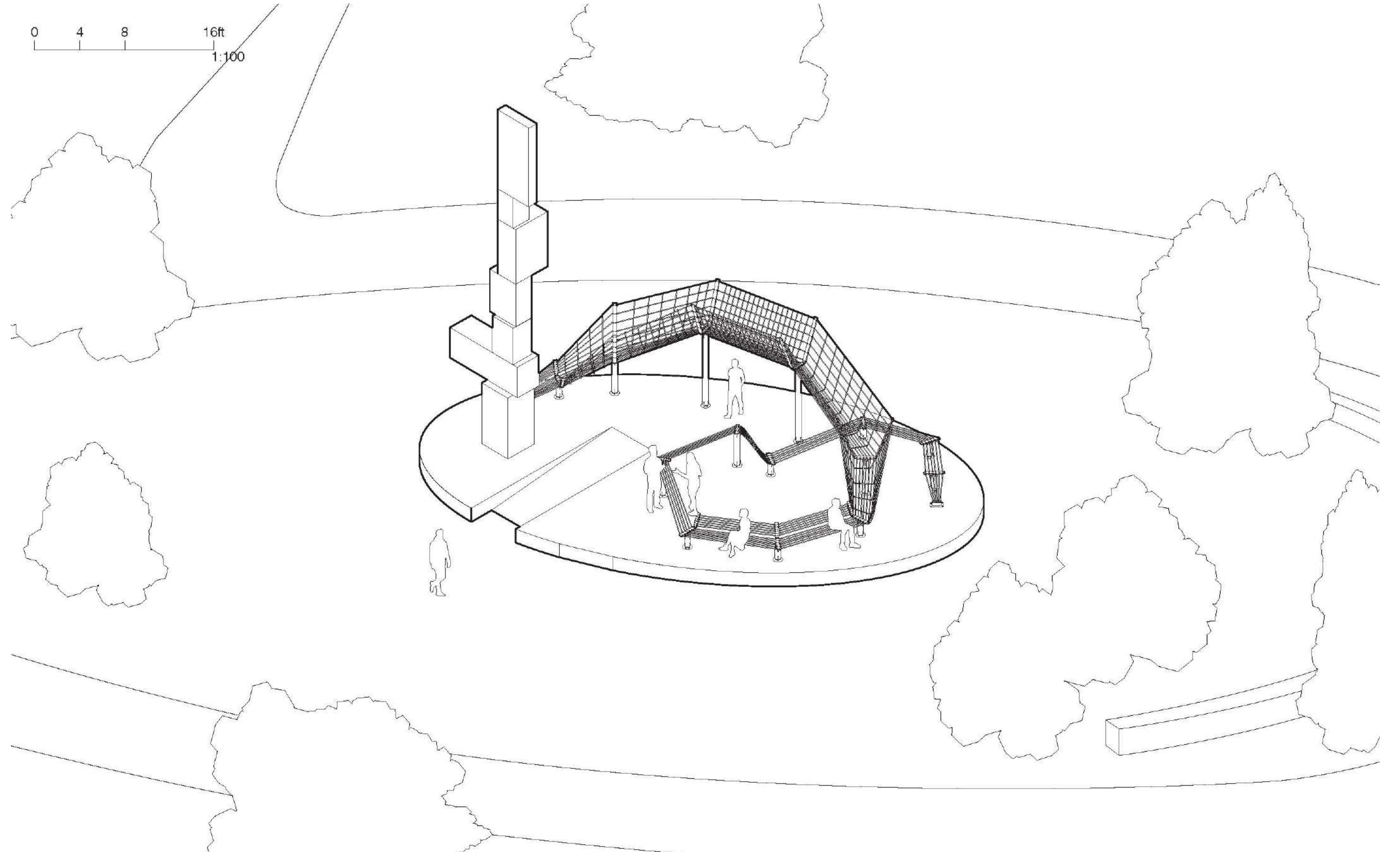

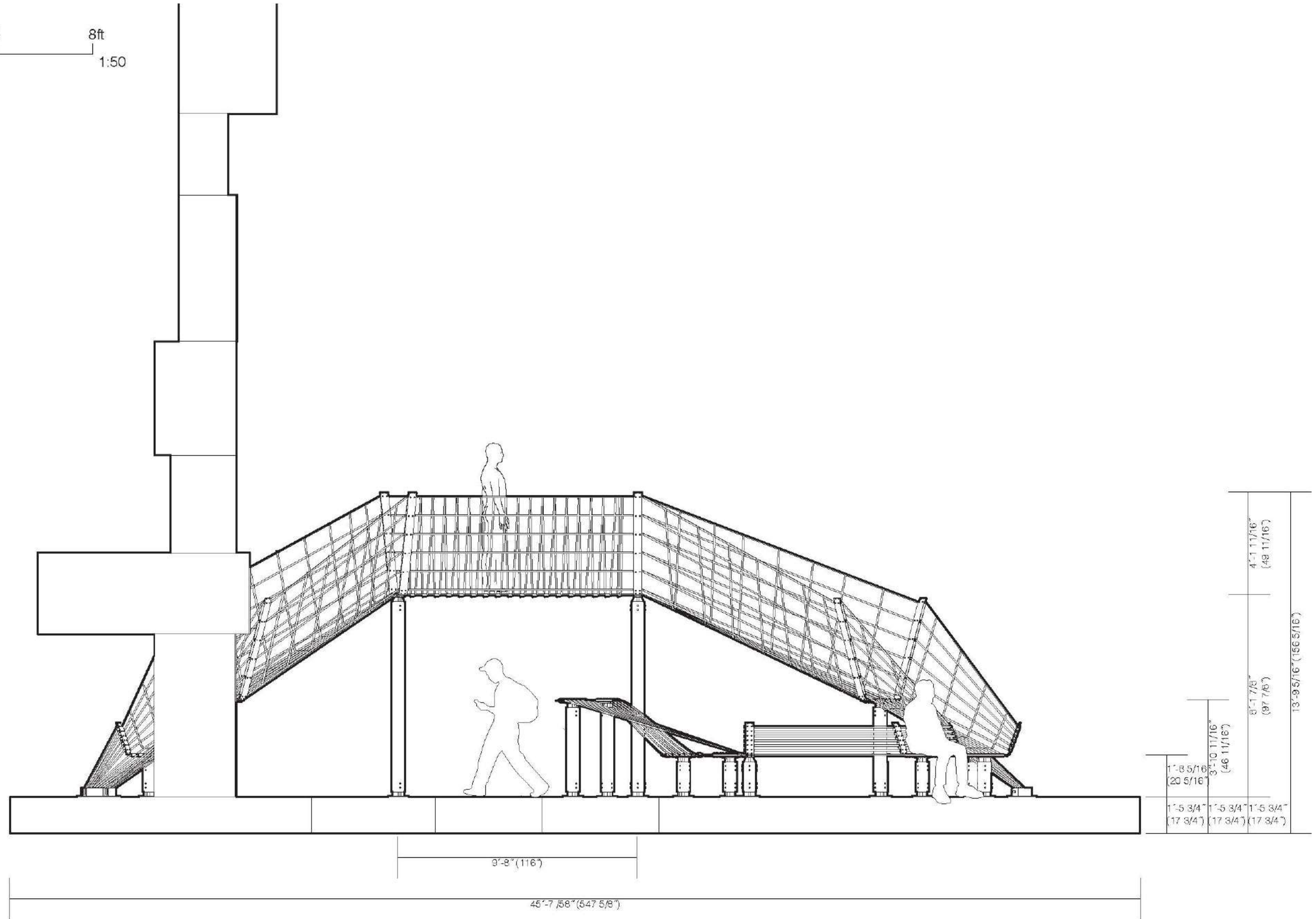
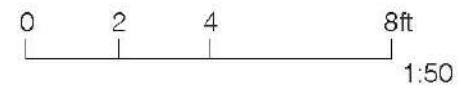

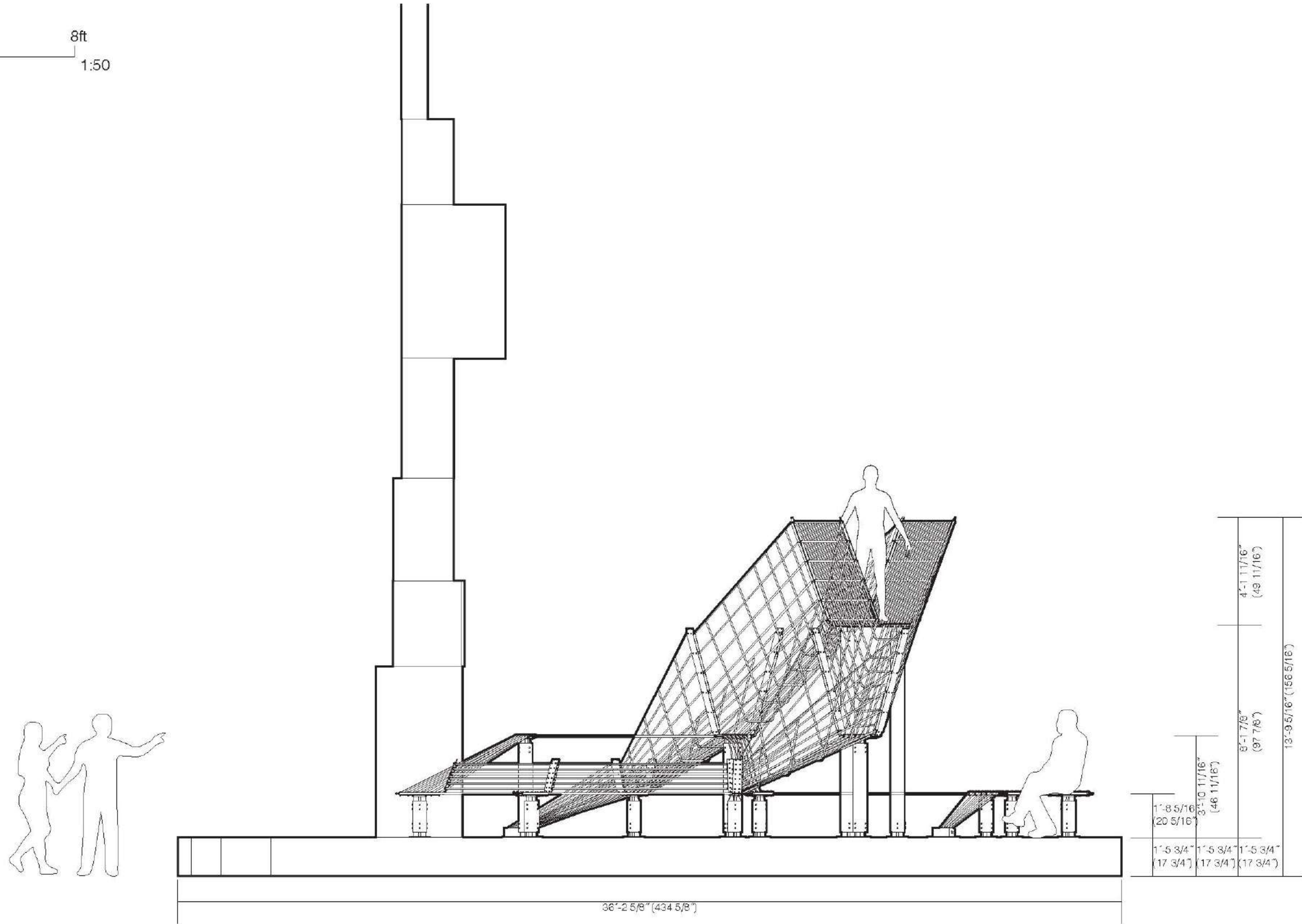
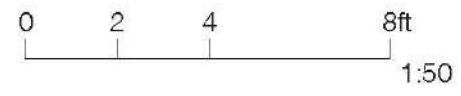

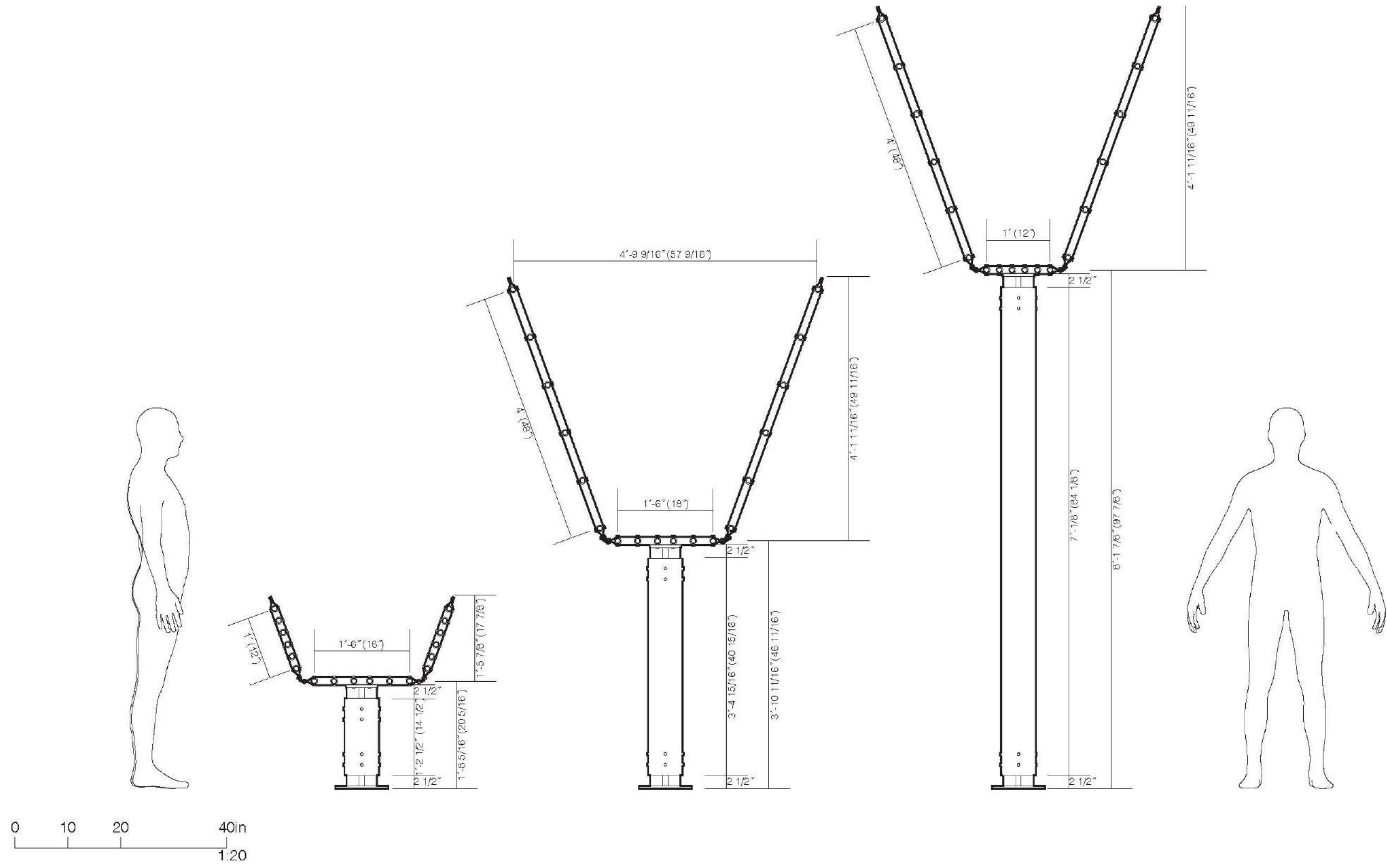

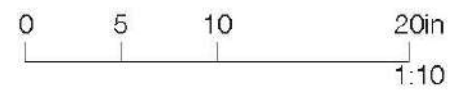
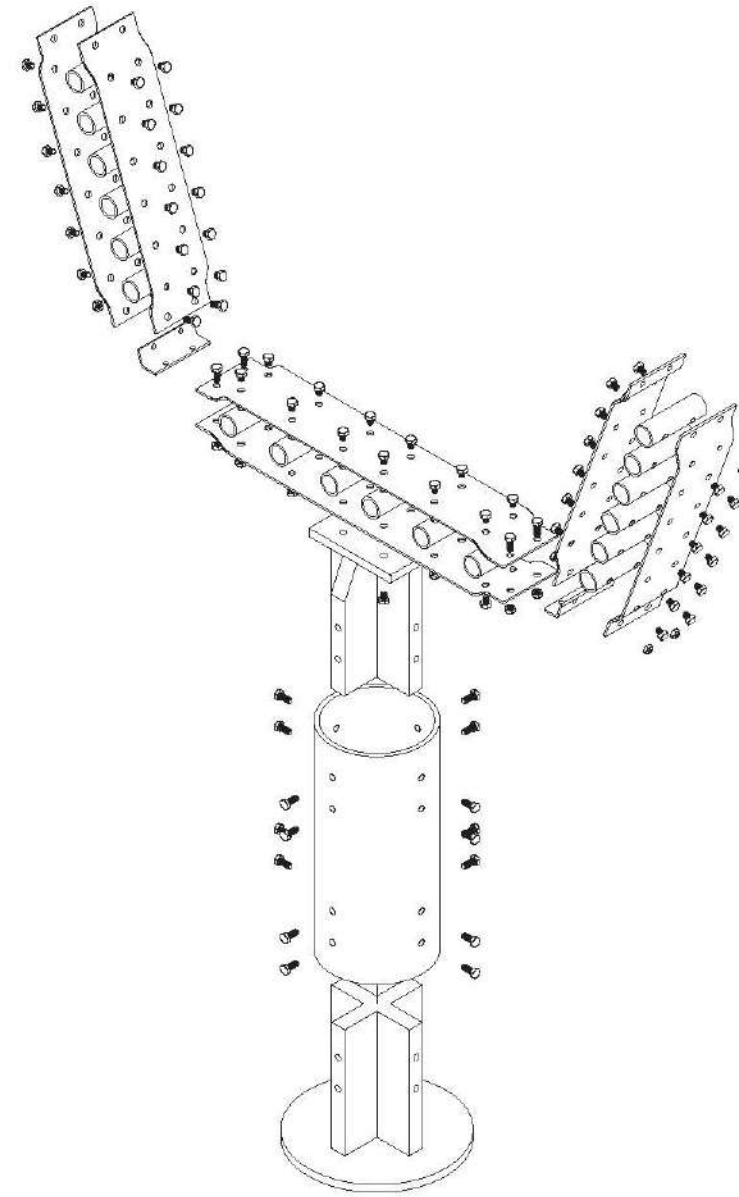
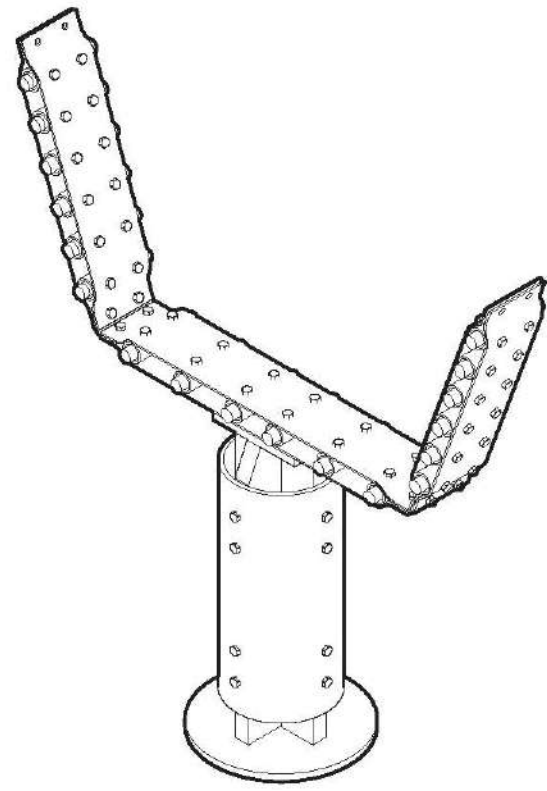

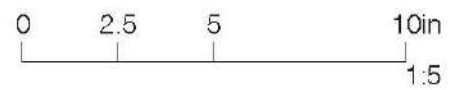
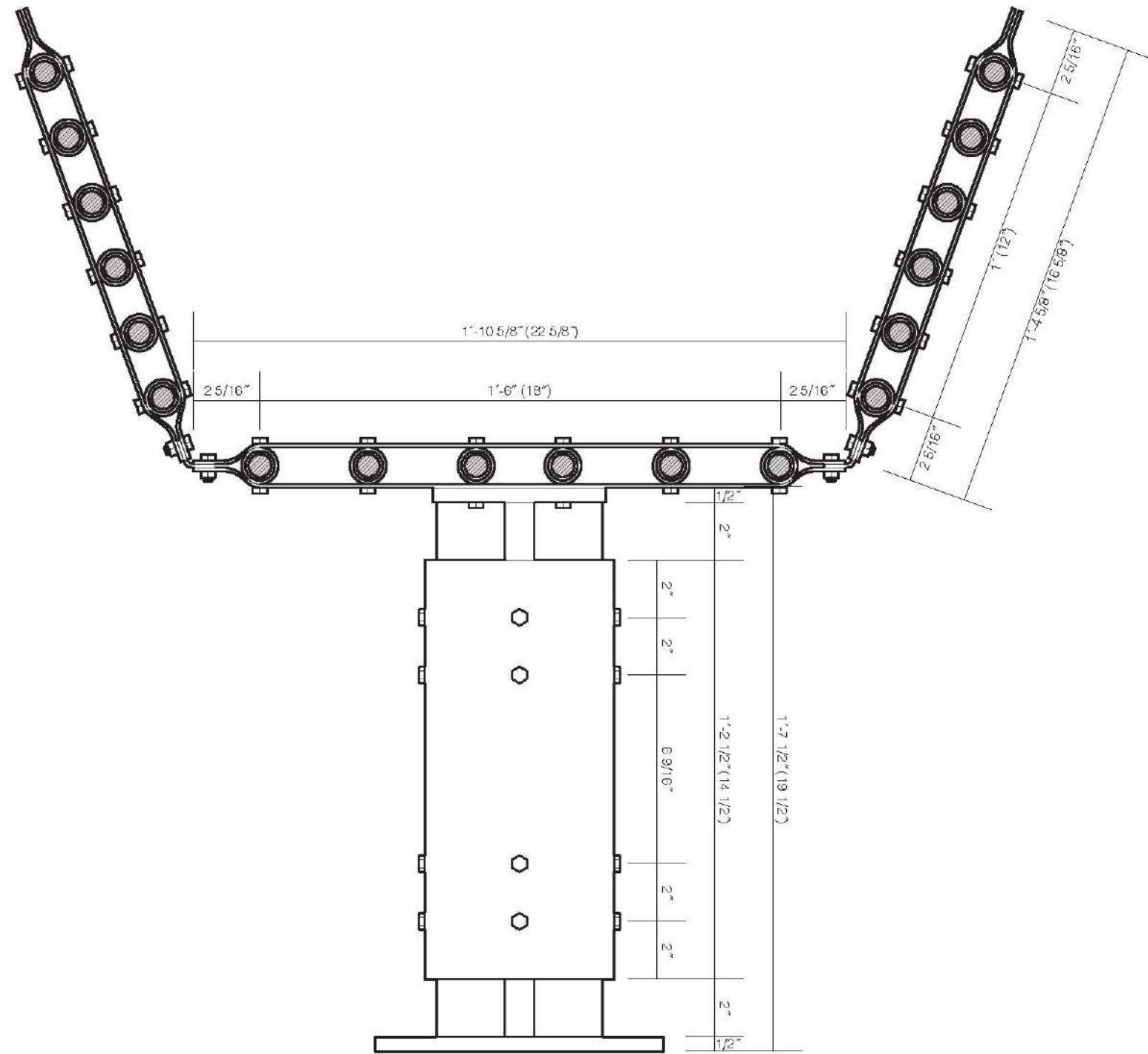

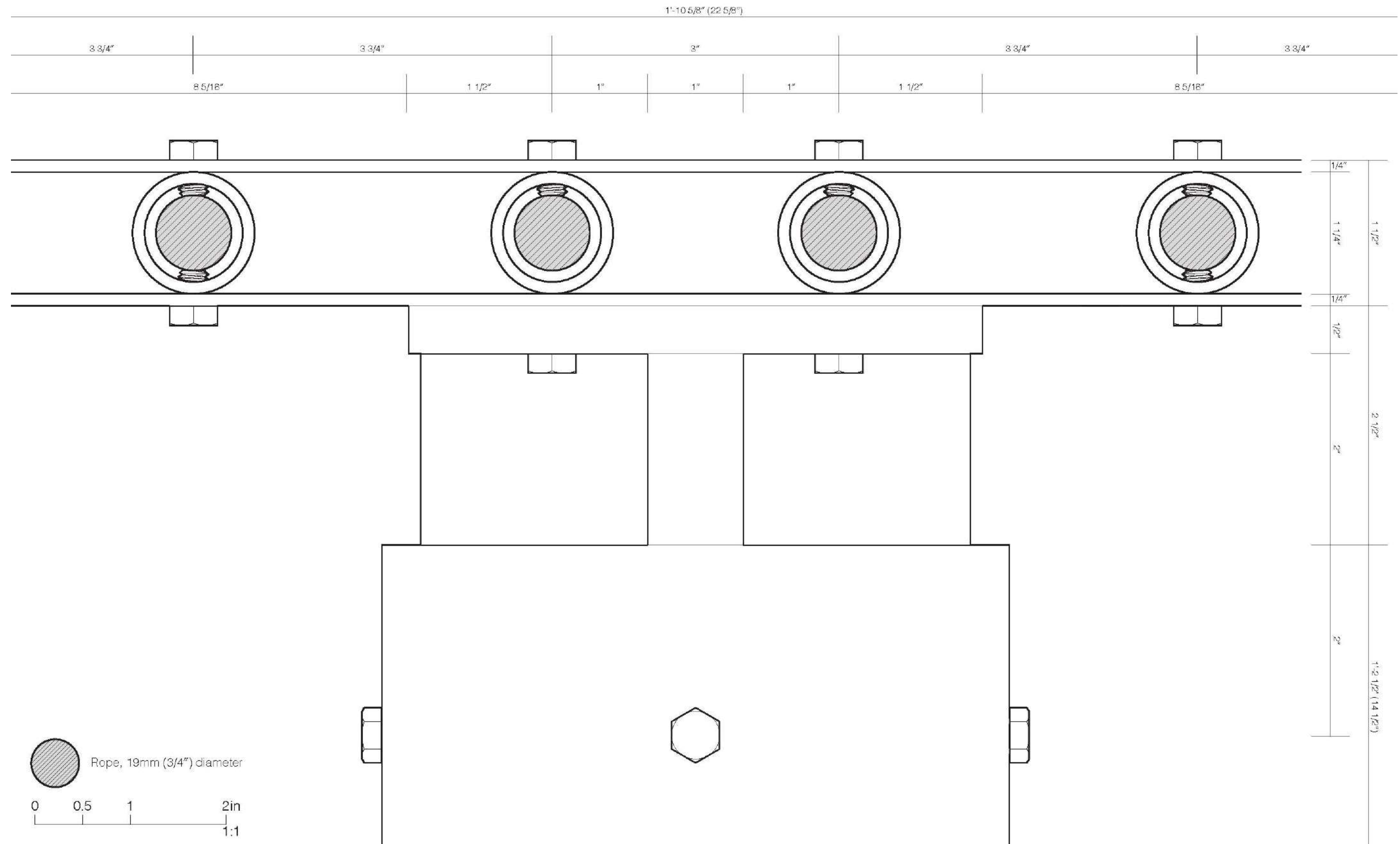

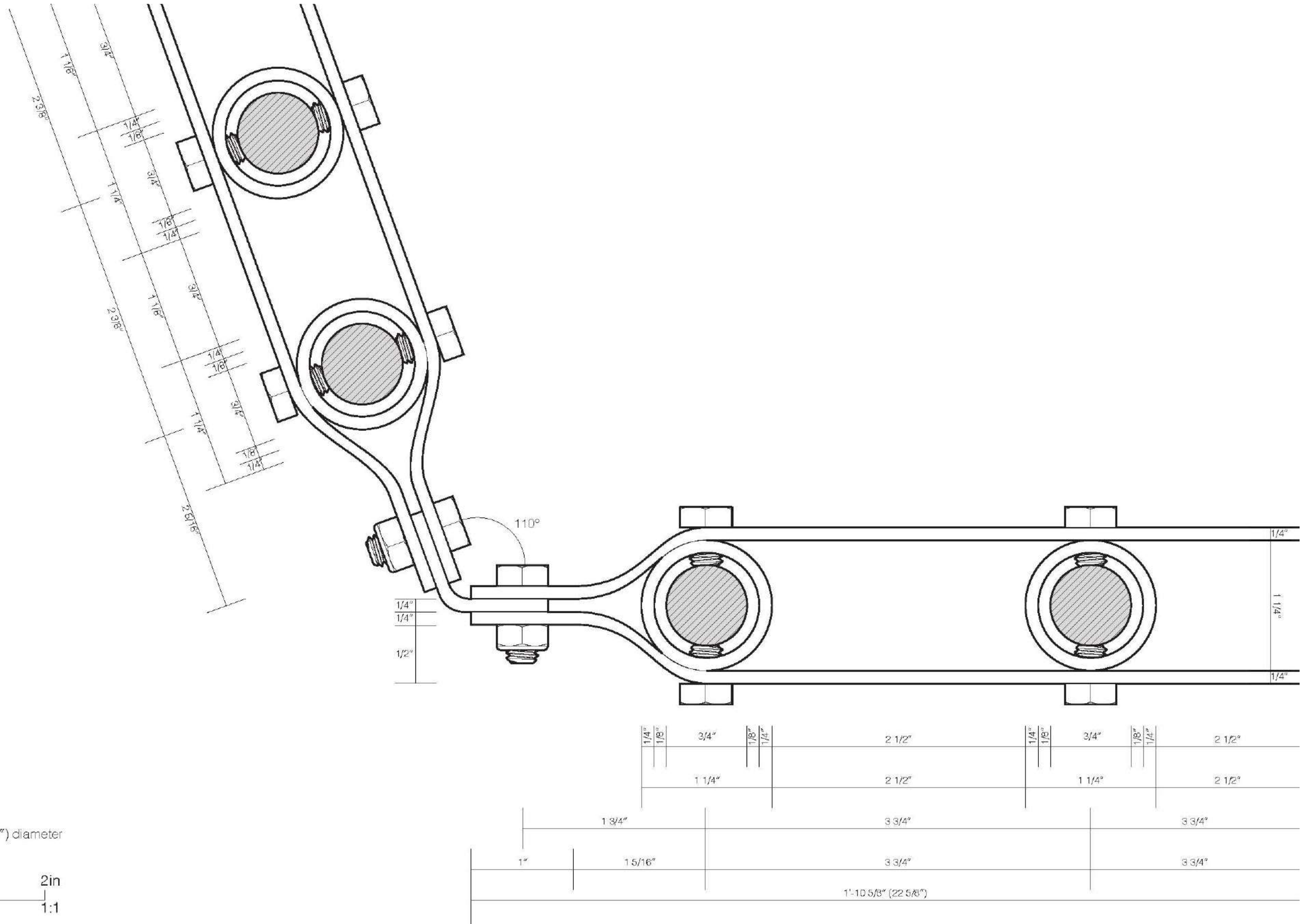

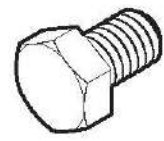

x 56
1/2" Hex Head Screw
(3/4" Long)

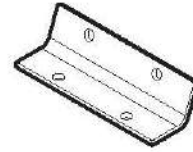

x 14
110° Guide Extender



x 8
Small Pole
(1'-2 1/2")

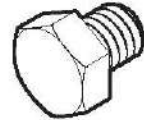

x 672
1/2" Hex Head Screw
(1/2" Long)

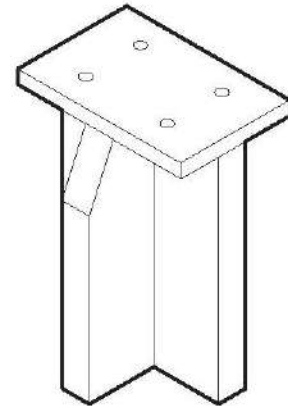

x 14
Pole Head



x 56
1/2" Hex Head Nut

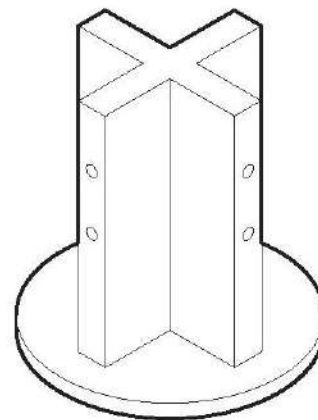

x 14
Pole Base



x 4
Medium Pole
(3'-4 15/16")

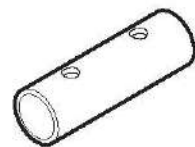

x 168
1 1/4" Pipe Rope Guide

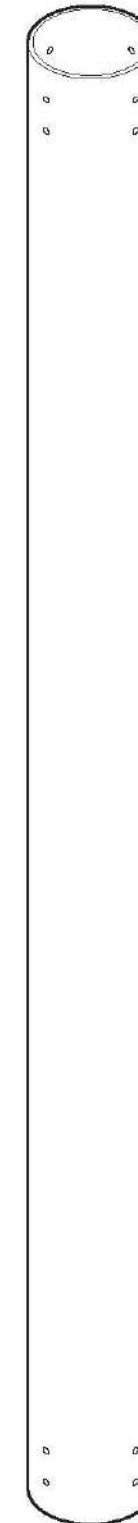

x 2
Tall Pole
(7'-1/8")

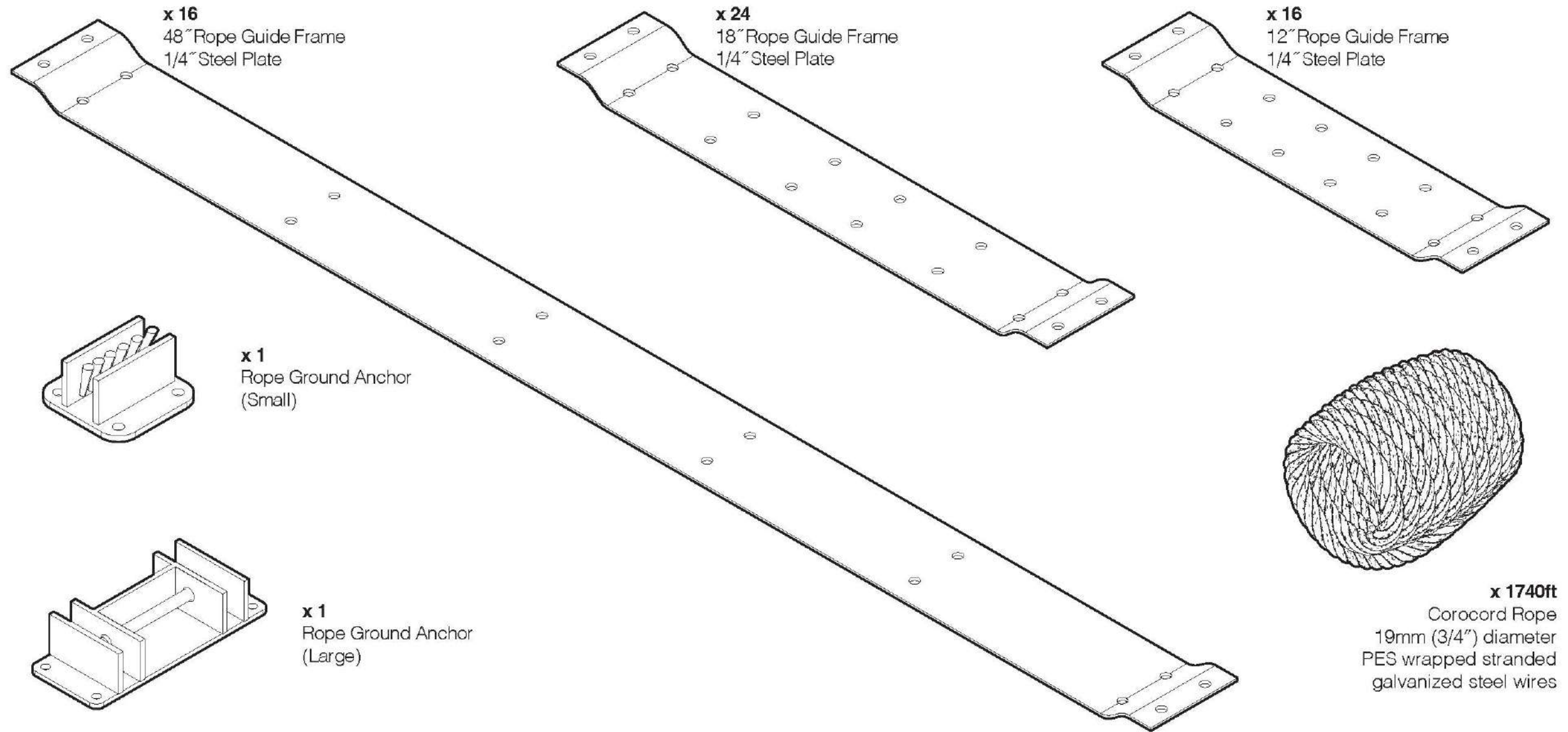



Neeraj Buch

Dean of Undergraduate Studies and
Associate Provost for Student Success
Rochester Institute of Technology

njbdfp@rit.edu



Enid Cardinal

Senior Advisor to the President for
Strategic Planning and Sustainability
Rochester Institute of Technology

elcpro@rit.edu



Josh Owen

Vignelli Center Director, School of Design
College of Art and Design
Rochester Institute of Technology

jkofaa@rit.edu



Donghwan Kim

Senior Manager of Electrical & Instrument
Construction
Daewoo Engineering & Construction Co.

donghwan1.kim@daewoenc.com



Reza Aliabadi

Architect

info@r2lbd.com